

Washington State University Libraries  
**All Libraries**  
Organization Chart – October 2018

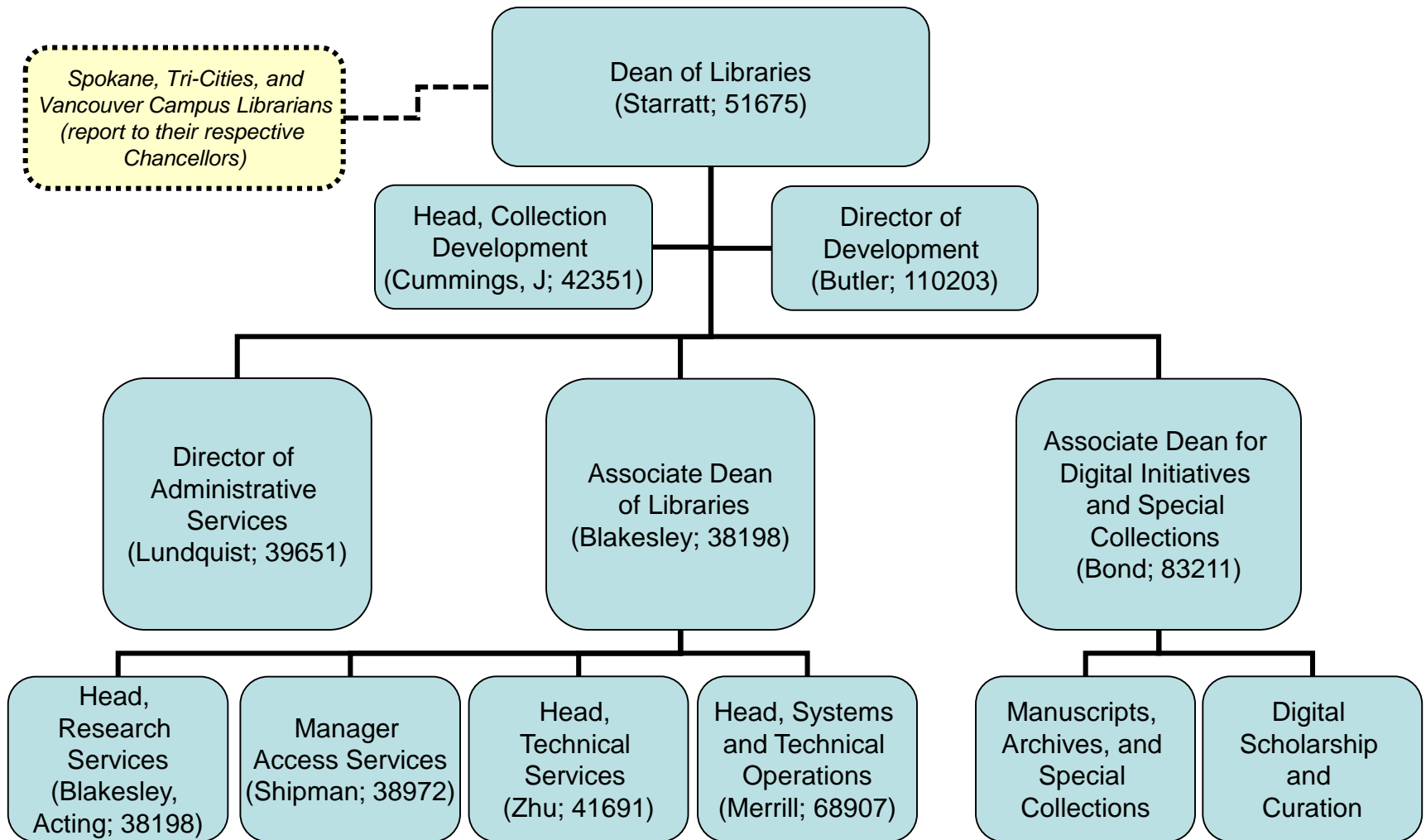

Washington State University Libraries  
**Dean of Libraries**  
Organization Chart – October 2018

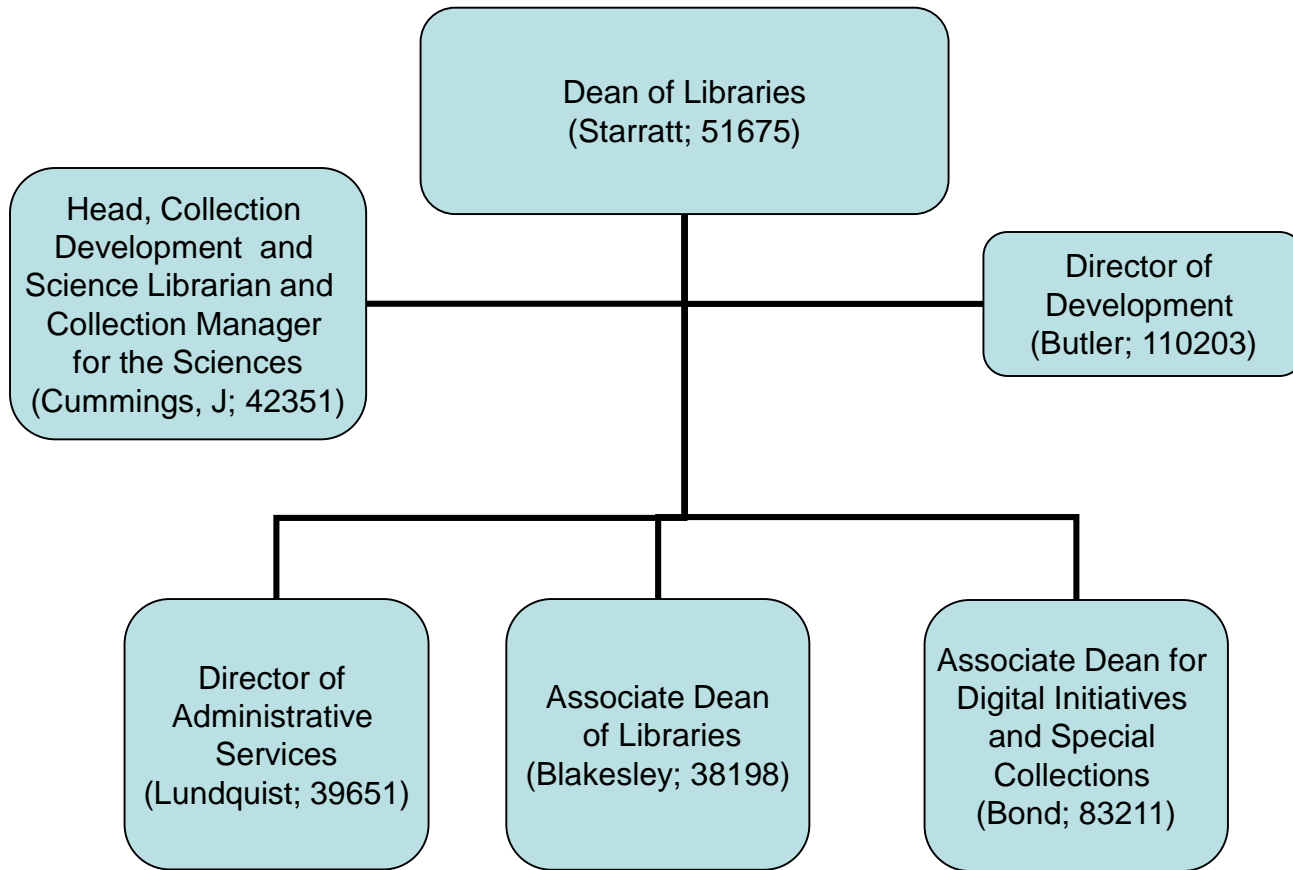

Washington State University Libraries  
**Library Administrative Office**  
Organization Chart – October 2018

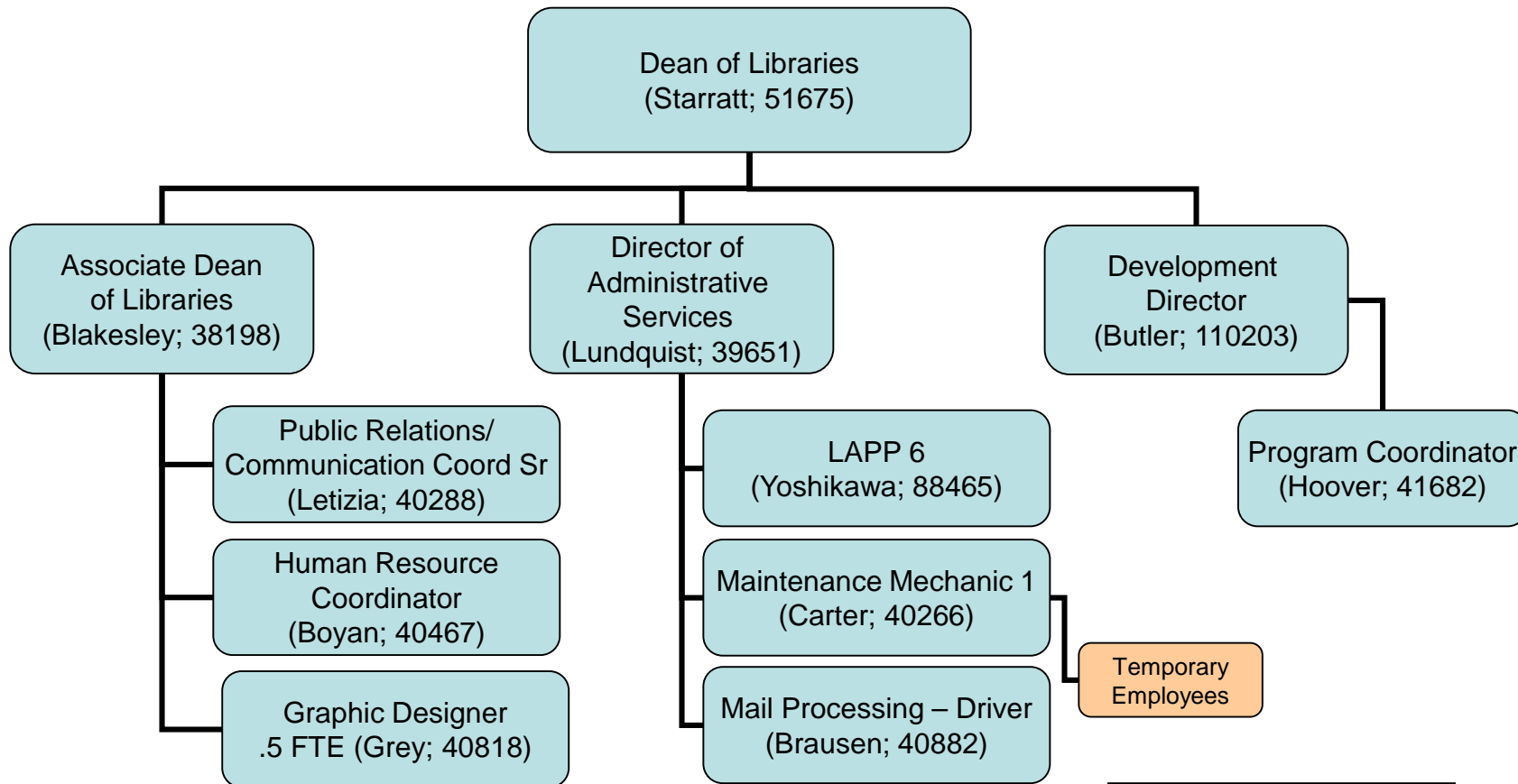

NOTE: LAPP = Library & Archives Paraprofessional

Washington State University Libraries  
**Associate Dean of Libraries**  
Organization Chart – October 2018

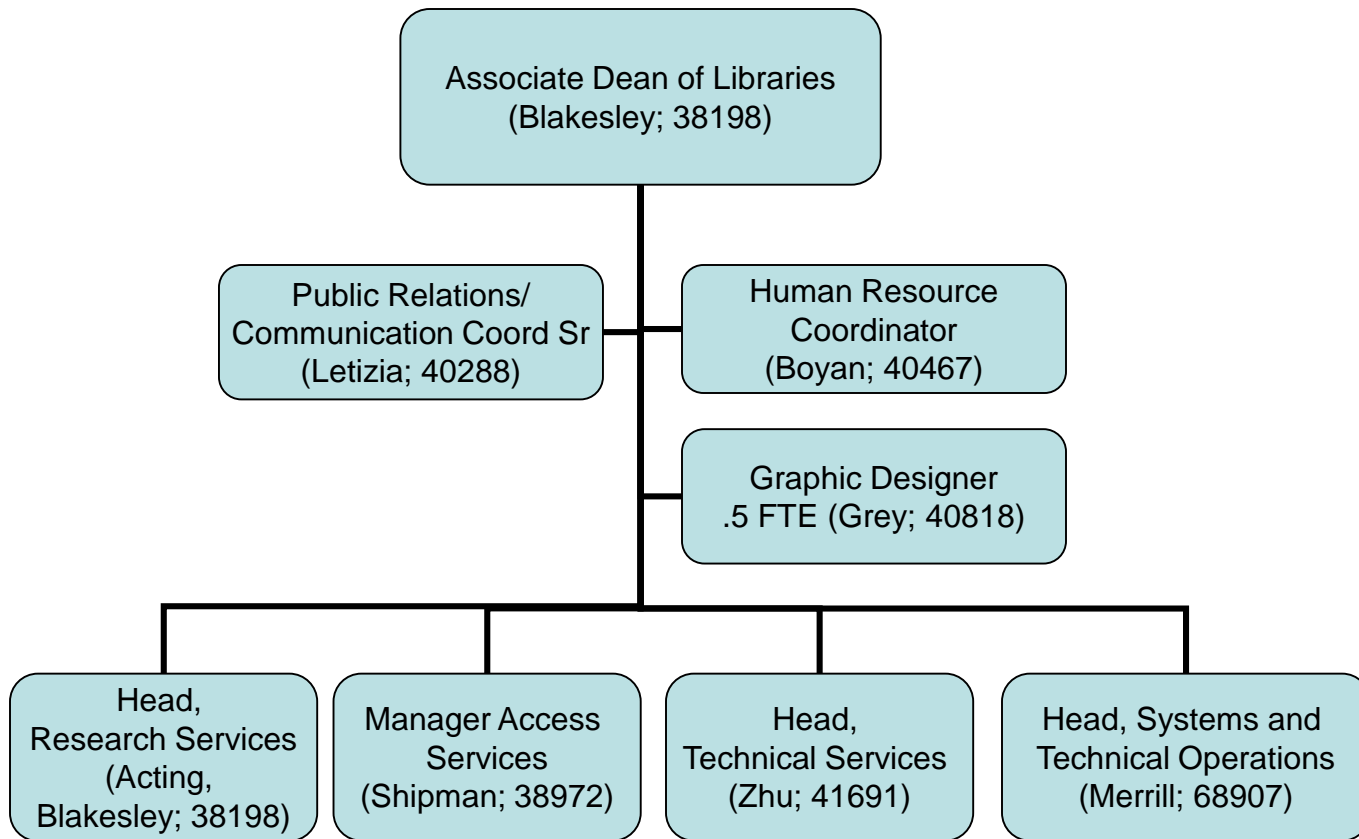

Washington State University Libraries  
**Research Services**  
Organization Chart – October 2018

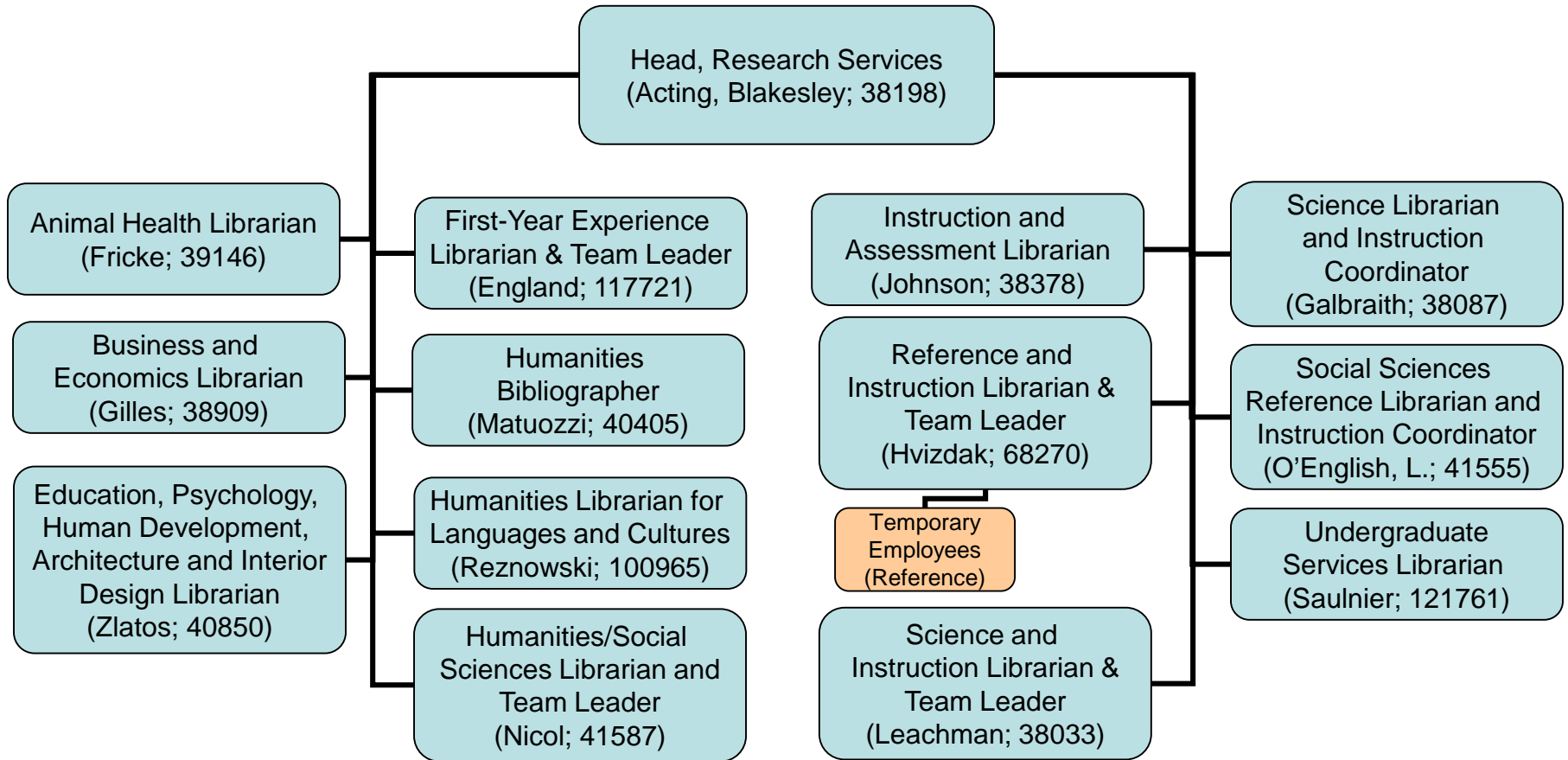

# Washington State University Libraries

## Access Services

### Organization Chart – October 2018

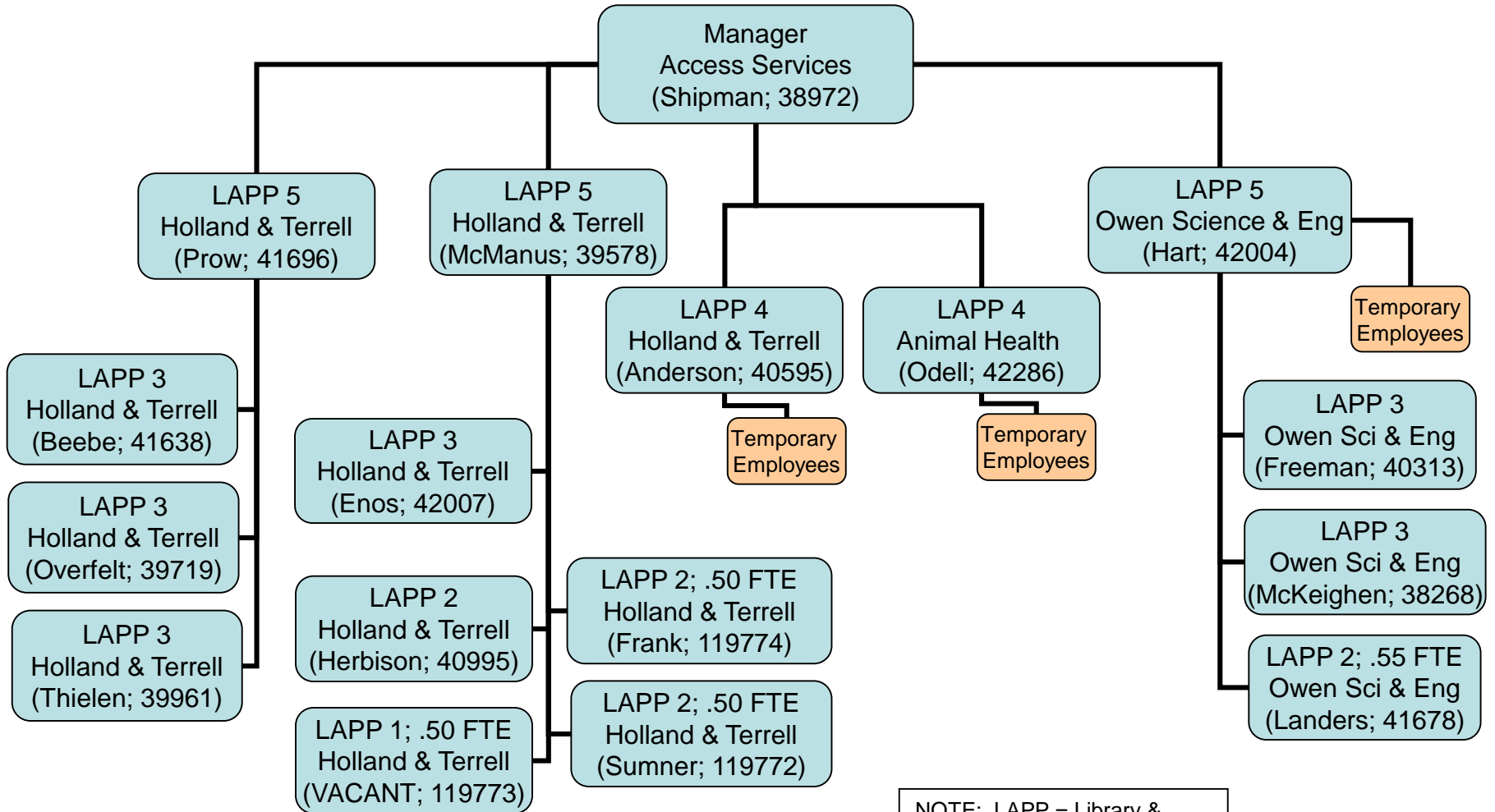

NOTE: LAPP = Library & Archives Paraprofessional

# Washington State University Libraries Systems

## Organization Chart – October 2018

NOTE: LAPP = Library &  
Archives Paraprofessional

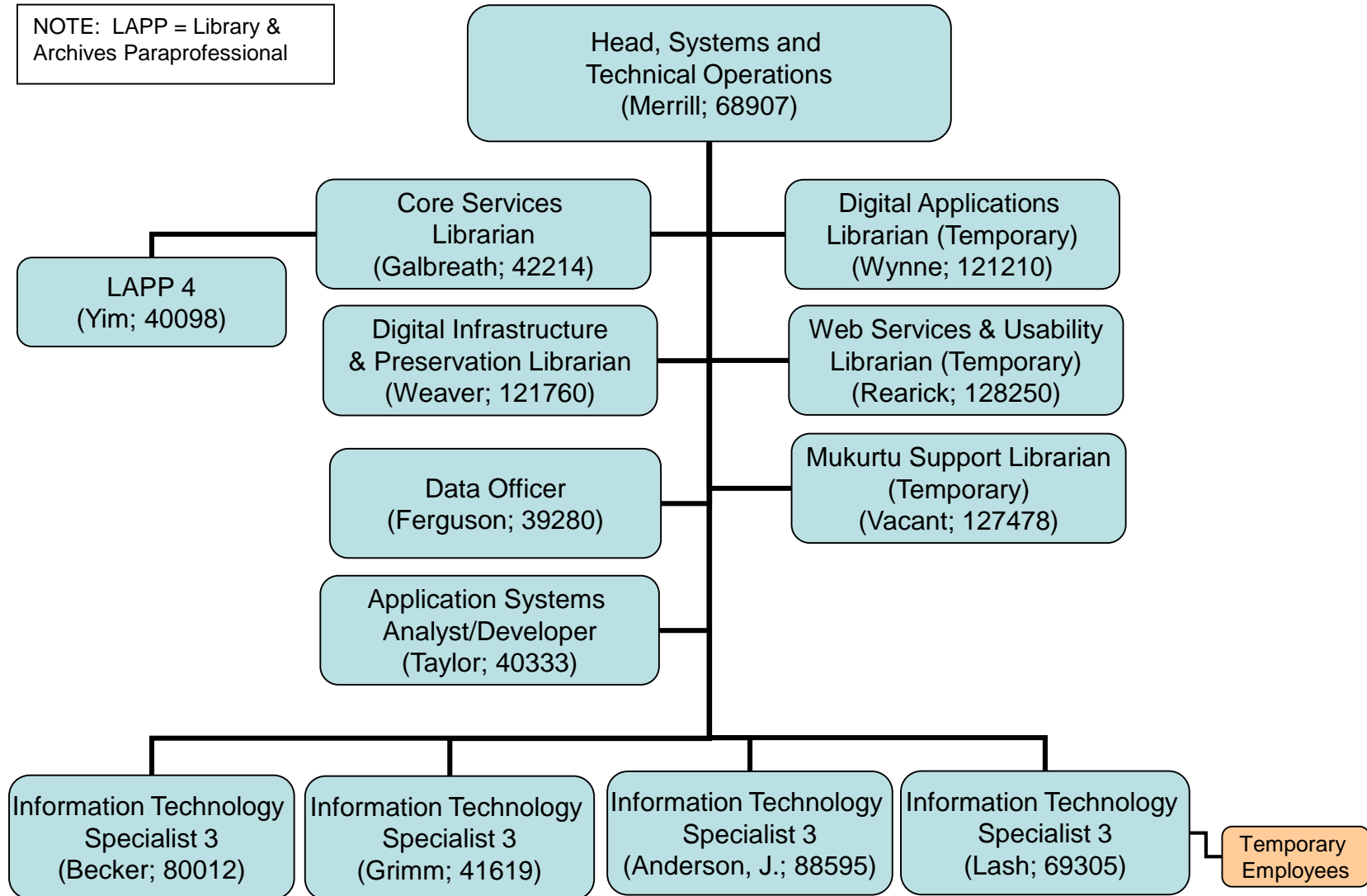

Washington State University Libraries  
**Technical Services**  
Organization Chart – October 2018

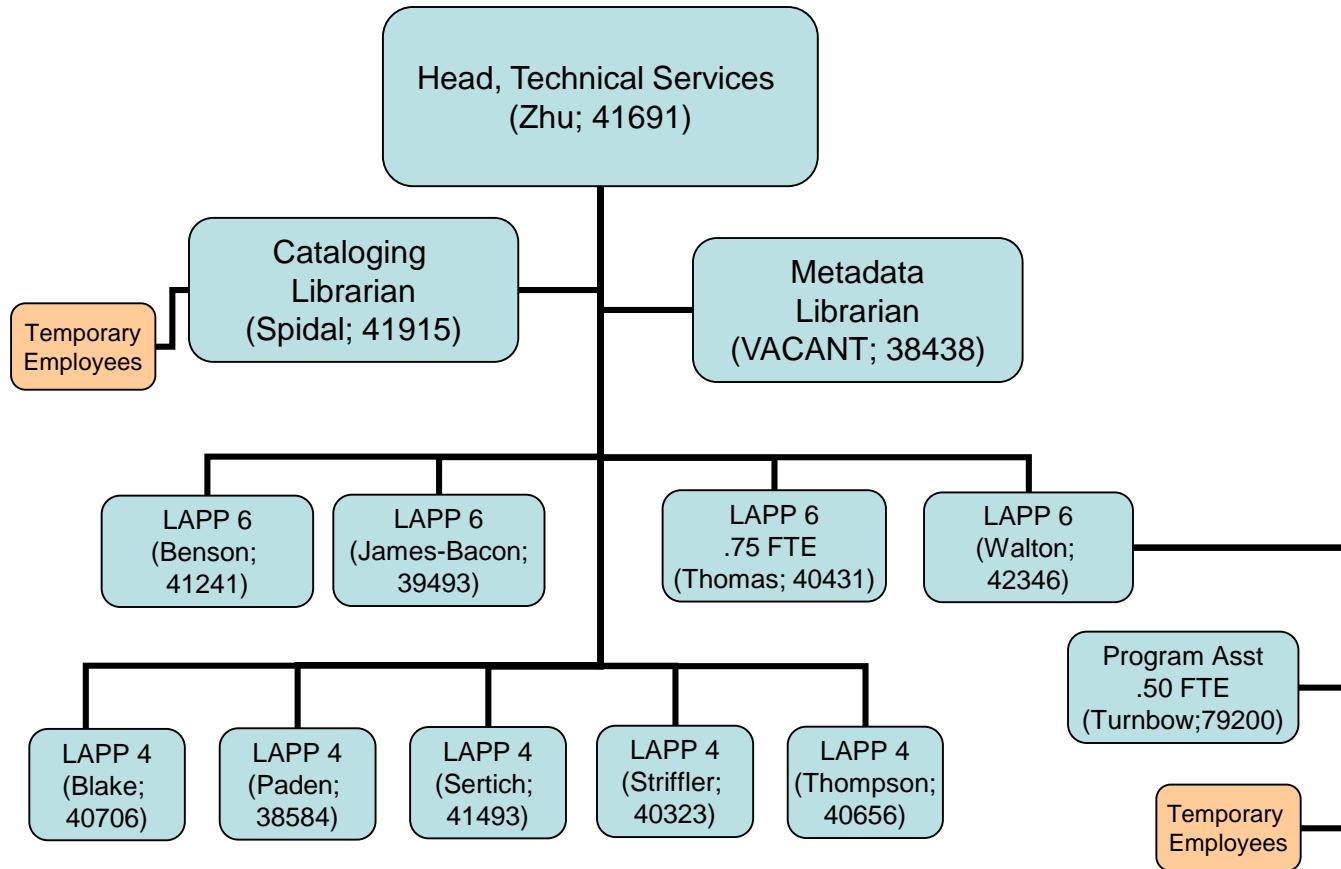

NOTE: LAPP = Library & Archives Paraprofessional



Washington State University Libraries  
**Manuscripts, Archives and Special Collections**  
Organization Chart – October 2018

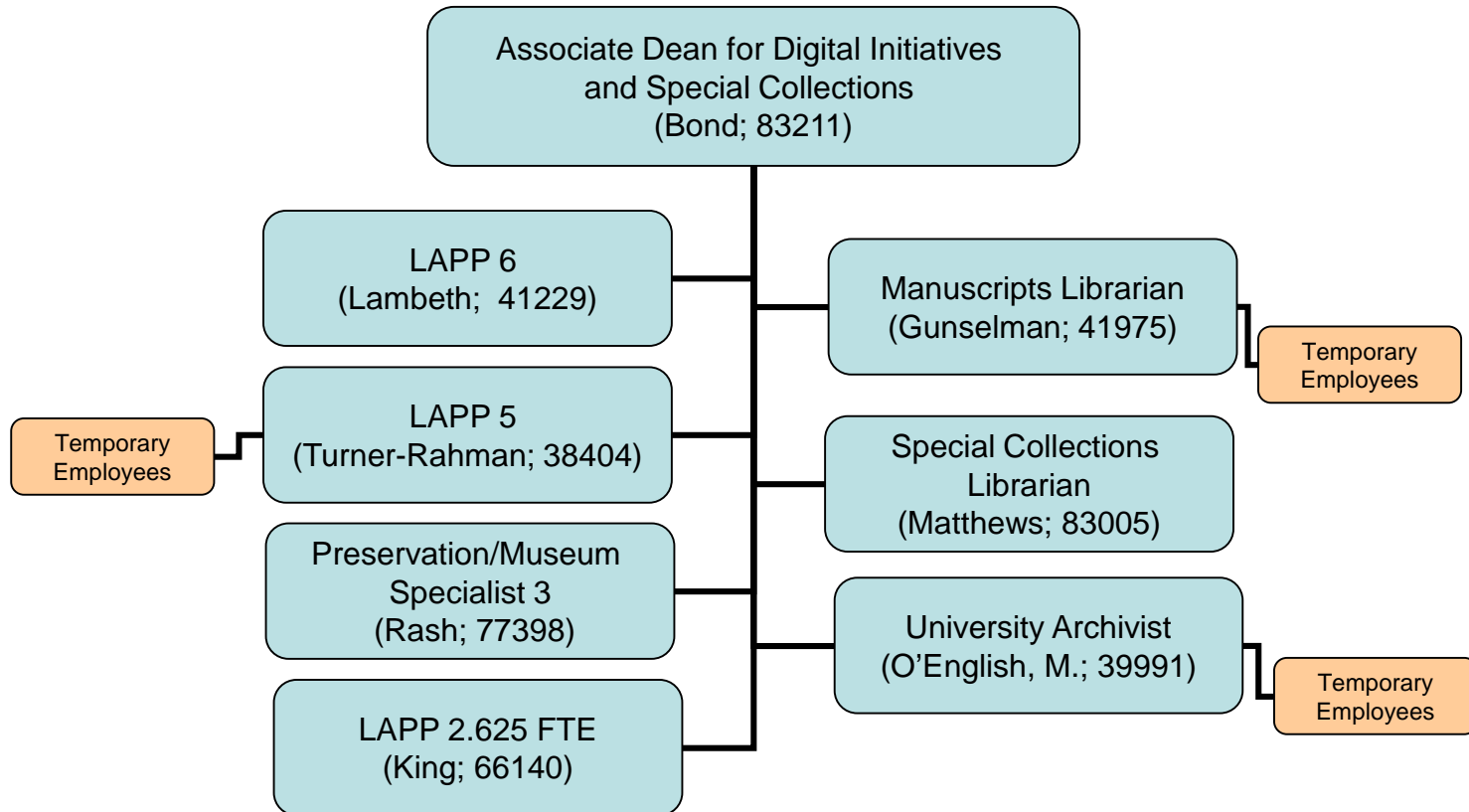

NOTE: LAPP = Library & Archives Paraprofessional

Washington State University Libraries  
**Digital Scholarship and Curation**  
Organization Chart – October 2018

